

下水道用マンホール調整リング(柵人孔)

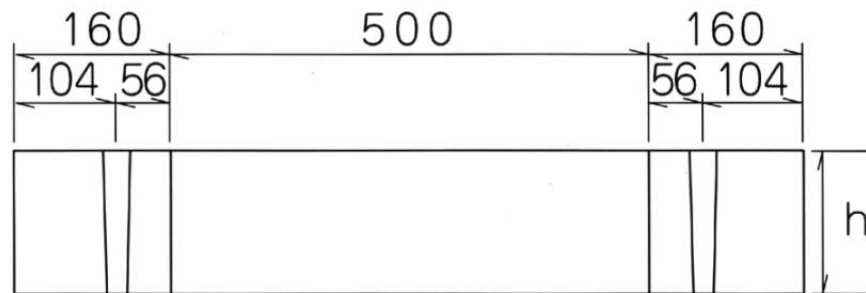
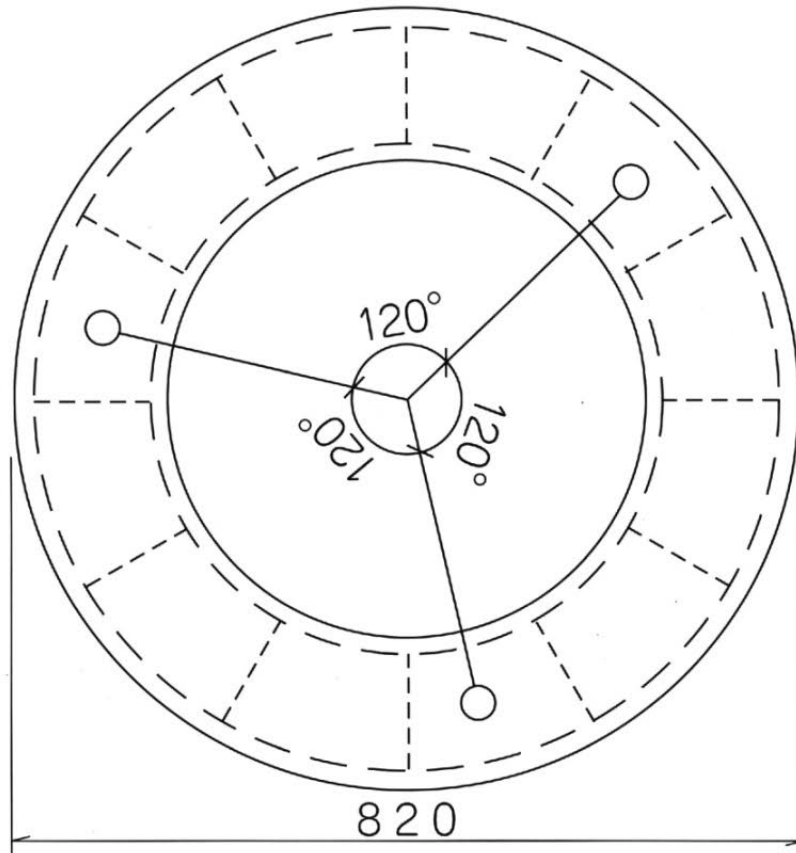

呼び名	h	主筋		副筋		重量 (kg)
		径(mm)	本数	径(mm)	本数	
2号(B)	100	6.0	4	4.0	12	78
3号(C)	150	6.0	4	4.0	12	117

柵 人 孔 (内径700mm)

呼 び 名	寸 法	重 量kg
異 形 甲	$\phi 600 \times \phi 700 \times 200$	192
1 号	$\phi 700 \times 300$	103
2 号	$\phi 700 \times 600$	206
3 号	$\phi 700 \times 1000$	344
底 版	$\phi 700 \times 80$	101

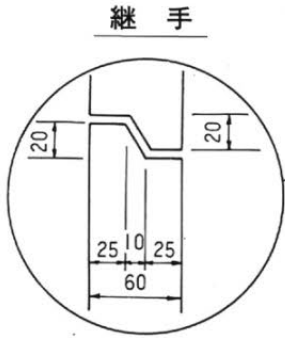
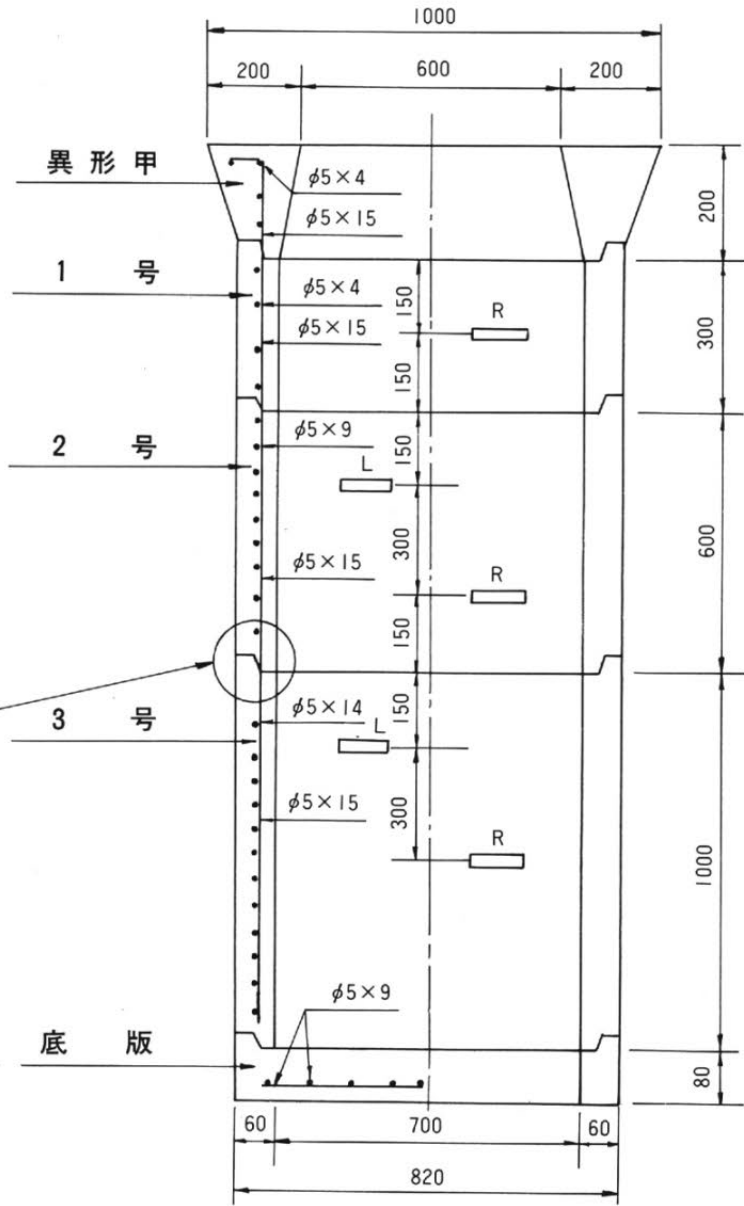

柵人孔 (内径700mm)

异形甲
237kg

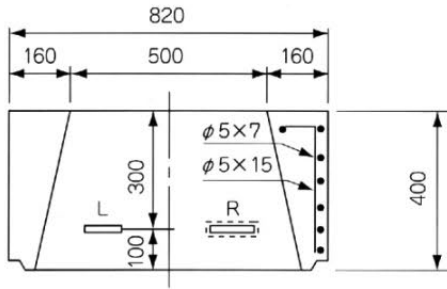

4号
344kg

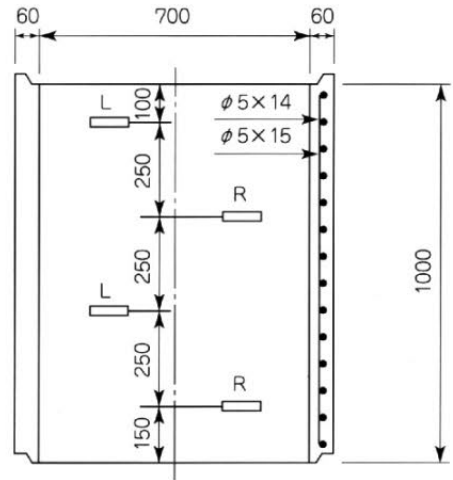

1号
69kg

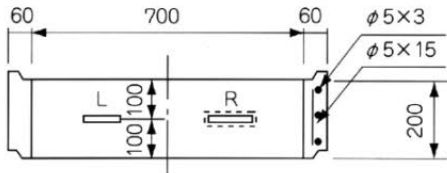

底塊
417kg

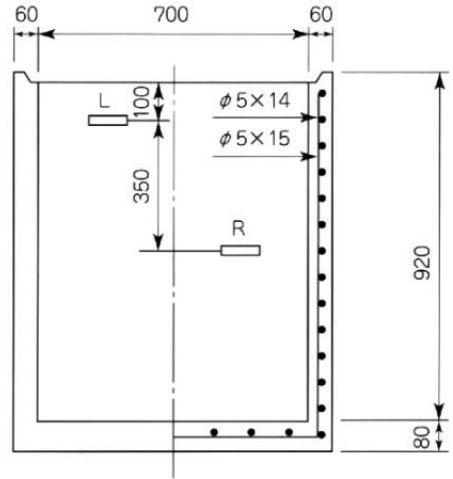

2号
172kg

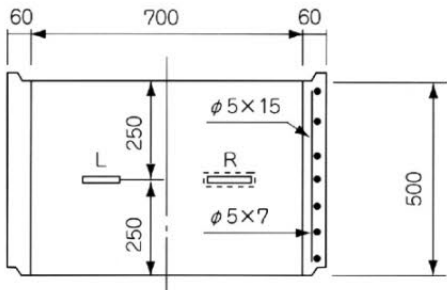

3号
241kg

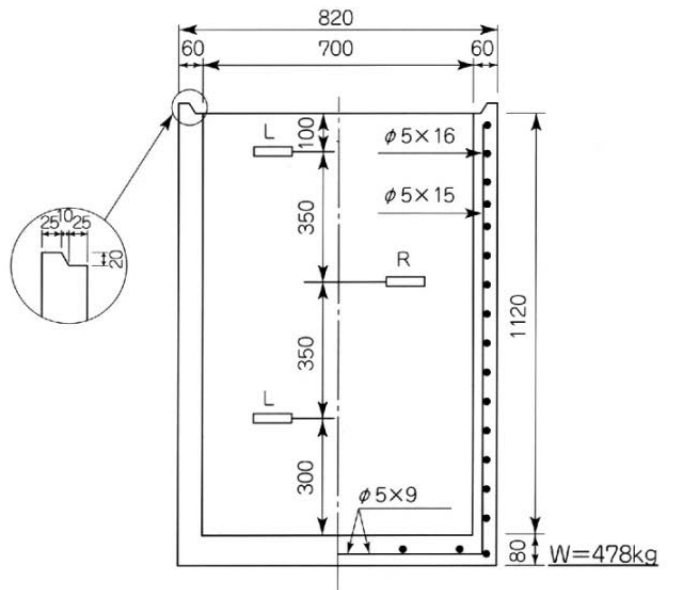
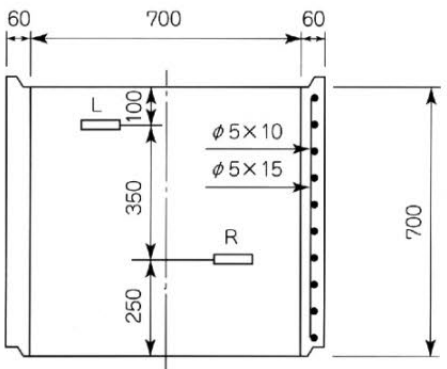

柵 人 孔 (内径700mm) ワイドステップ

